

Summary of Technical Data Sheet

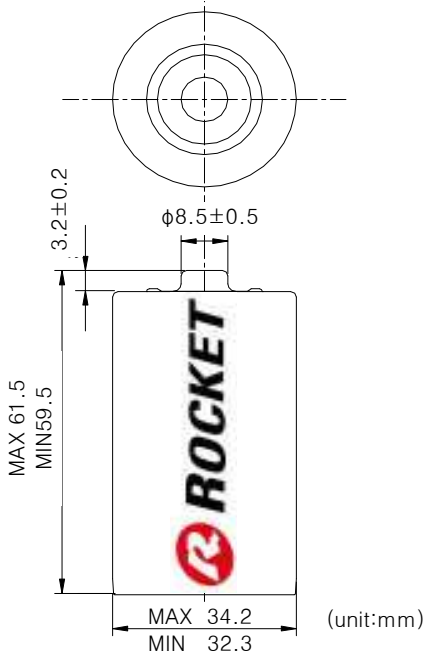

**D SIZE
(LR20)**



Specifications

Classification:	Alkaline
Chemical system:	Zinc-Maganese Dioxide(Zn/MnO ₂) (No added mercury or cadmium)
Designation:	IEC / KS / JIS LR20
Nominal voltage:	1.5 volts
Allowed voltage:	1.50 ~ 1.650 volts
Average weight:	131.0 grams
Terminal:	Flat
Outer jacket:	Plastic Label
Operation range:	0~30℃

1. Test condition at 20±2℃, 65±20% RH

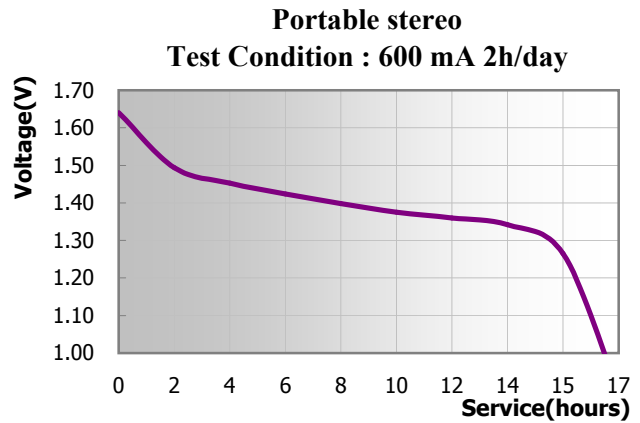
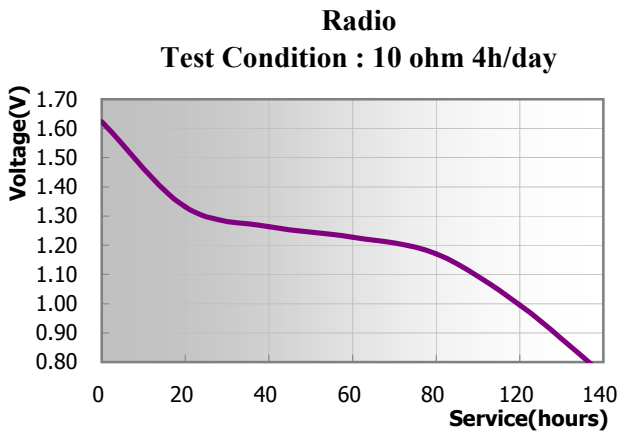
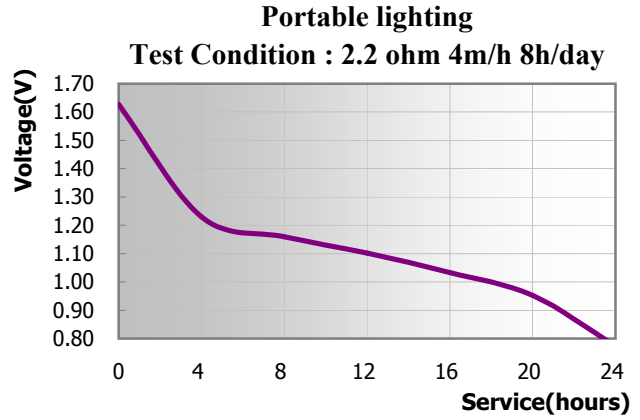
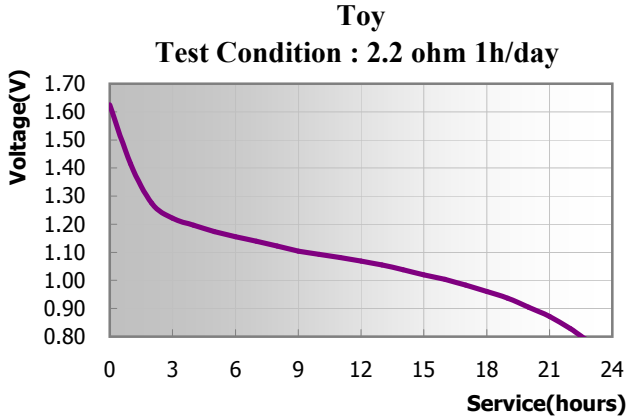

2. Capacity for constant current

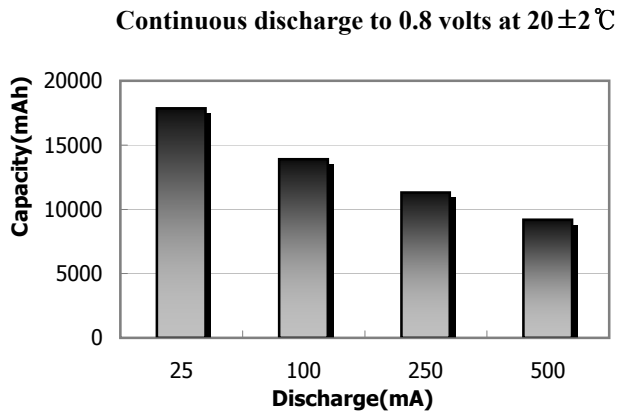

3. Temperature range for operating

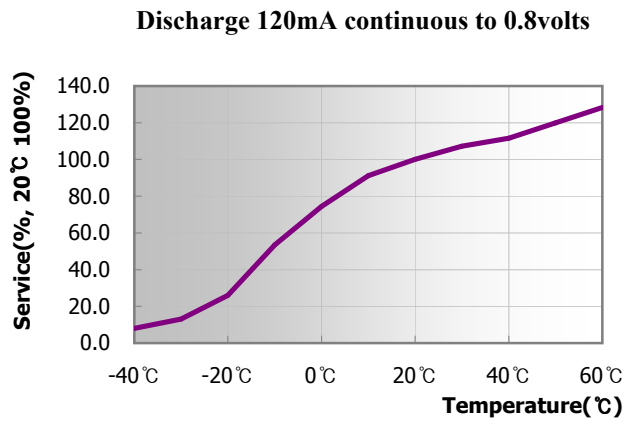

Important Notice

This data sheet contains typical information specific to products manufactured at the time of its publication.

Contents herein do not constitute a warranty.

Copyright©rocket. Co.kr - All rights reserved.